

Installation

Installatie, Installasjon

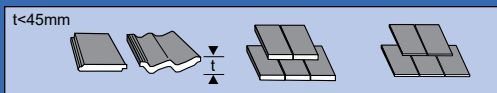

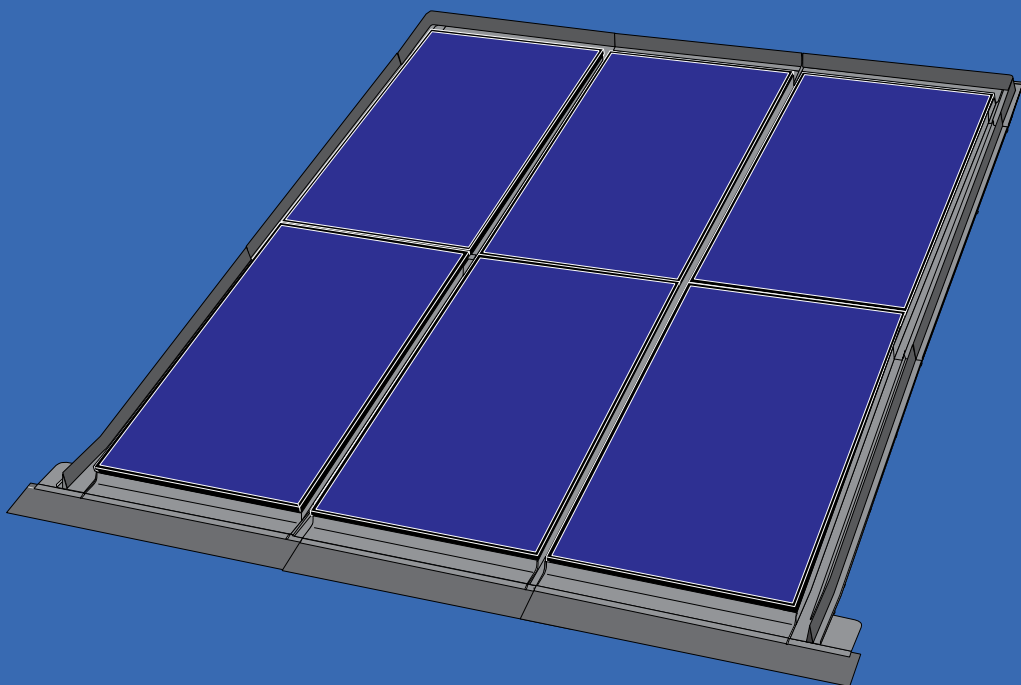
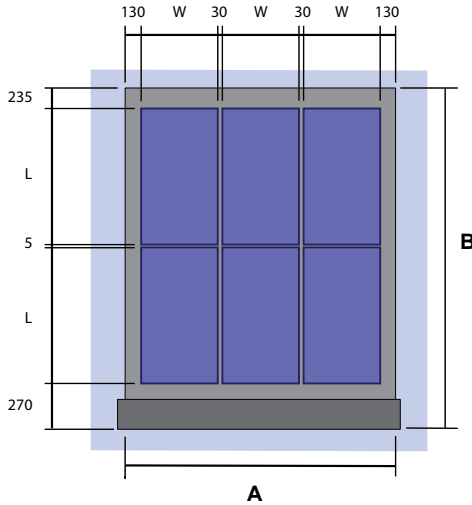

n x m

n			
2			
1	2	3	m

	G1 (eg PV16-340-G1)	G1 (eg PV16-300)
A	$(m \times 1030) + 230$	$(m \times 1022) + 230$
B	$(n \times 1691) + 500$	$(n \times 1645) + 500$
W	1000	992
L	1686	1640

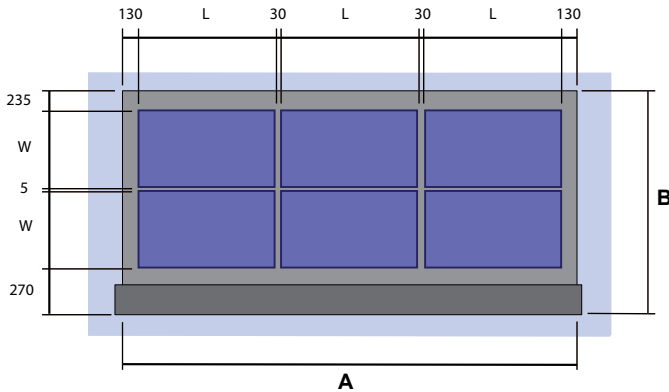

n x m

n		
3		
2		
1	2	m

	G1 (eg PV16-340-G1)	G1 (eg PV16-300)
A	$(m \times 1716) + 230$	$(m \times 1670) + 230$
B	$(n \times 1005) + 500$	$(n \times 997) + 500$
W	1000	992
L	1686	1640

EN

Mechanical Specification

Thickness	mm	69
Static roof loading (distributed)	kg/m ²	12,9
Characteristic Wind Resistance	kPa	5,32
Ultimate Wind Design Load ¹	kPa	5,32
Positive Design Load (IEC61215)	kPa	5,40
Fire Rating (EN 13501-5 / BS 476-3)		B _{ROOF} (T ₁ , T ₂ , T ₃ , T ₄) / AA
Power Warranty	% rated	90% 10 years, 80% 25 years
Standards		IEC61215, 61730, TUV, MCS012

¹ Design resistance to ultimate loads includes a partial material safety factor of 1.0
Tested batten size - 50mm x 25mm, rafter 35mm x 75mm, rafter spacing 600mm. For sarking brackets - softwood sarking boards 100mm x 22mm

DE

Mechanische Spezifikationen

Dicke	mm	69
Statische Dachlast (verteilt)	kg/m ²	12,9
Charakteristische Windbeständigkeit	kPa	5,32
Bemessungsgrenzlast ¹	kPa	5,32
Statik und Lastannahme (IEC 61215)	kPa	5,40
Feuerwiderstandsklasse (EN 13501-5)		B _{ROOF} (T ₁ , T ₂ , T ₃ , T ₄)
Leistungsgarantie	% der Nennleistung	90% 10 Jahre, 80% 25 Jahre
Normen		IEC61215, 61730, TUV

¹ Der Bemessungswiderstand gegen Grenzlaster beinhaltet einen Teilsicherheitsbeiwert von 1,0.
Geprüft mit den folgenden Materialien und Abmessungen: Dachlatten - 50mm x 25mm, Dachsparren - 35mm x 75mm, Dachsparrenabstand - 600mm.

NL

Mechanische Specificatie

Dikte	mm	69
Statische dakbelasting (verspreid)	kg/m ²	12,9
Karakteristieke wind resistentie	kPa	5,32
Ultieme wind ontwerpbelasting ¹	kPa	5,32
Positieve ontwerpbelasting (IEC 61215)	kPa	5,40
Brandklasse (EN 13501-5)		B _{ROOF} (T ₁ , T ₂ , T ₃ , T ₄)
Vermogensgarantie	% beoordeeld	90% 10 Jahre, 80% 25 Jahre
Normen		IEC61215, 61730, TUV

¹ Ontwerpweerstand tegen ultieme belastingen omvat een gedeeltelijke materiaalveiligheidsfactor van 1,0.
Geteste panlatmaat - 50mm x 25mm, spant 35mm x 75mm, spantafstand 600mm

NO

Mekaniske Spesifikasjoner

Tykkelse	mm	69
Statisk takbelastning(fordelt)	kg/m ²	12,9
Vindmotstand	kPa	5,32
Maksimal vind Last ¹	kPa	5,32
Positive testresultater iht (IEC61215)	kPa	5,40
Brannklasse (EN13501-5:2006)		B _{ROOF} (T ₁ , T ₂ , T ₃ , T ₄)
Effektgaranti	% av referanse	90% 10 år, 80% 25 år
Standarder		IEC61215, 61730, TUV

¹ Designet for store belastninger inkluderer en material sikkerhetsfaktor på 1,0
Testet lekte (slisse) størrelse-50mm x 25mm, Lektor 35mm x 75mm, Lekte avstand 600mm



1 x 2

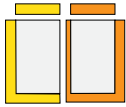

- Clearline PV16 ____ 2
- F16-TL ____ 1
- F16-TR ____ 1

1 x 4

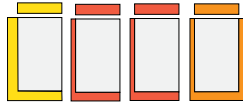

- Clearline PV16 ____ 4
- F16-TL ____ 1
- F16-TC ____ 2
- F16-TR ____ 1

2 x 2

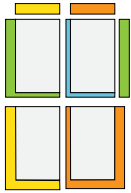

- Clearline PV16 ____ 4
- F16-TL ____ 1
- F16-TC ____ 0
- F16-TR ____ 1
- F16-TY ____ 1
- F16-J ____ 1

2 x 3

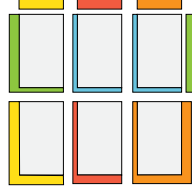

- Clearline PV16 ____ 6
- F16-TL ____ 1
- F16-TC ____ 1
- F16-TR ____ 1
- F16-TY ____ 1
- F16-J ____ 2

2 x 4

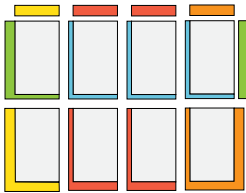

- Clearline PV16 ____ 8
- F16-TL ____ 1
- F16-TC ____ 2
- F16-TR ____ 1
- F16-TY ____ 1
- F16-J ____ 3

2 x 1



- Clearline PV16 ____ 2
- VAT16 ____ 1
- F16-TY ____ 1

3 x 3

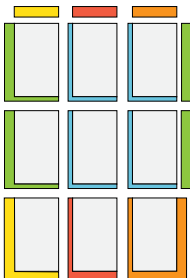

- Clearline PV16 ____ 9
- F16-TL ____ 1
- F16-TC ____ 1
- F16-TR ____ 1
- F16-TY ____ 2
- F16-J ____ 4

n x m

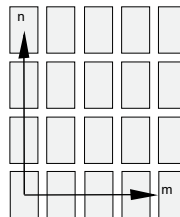

- Clearline PV16 ____ (n x m)
- F16-TL ____ 1
- F16-TC ____ (m-2)
- F16-TR ____ 1
- F16-TY ____ (n-1)
- F16-J ____ (n-1) x (m-1)



1 x 2



- Clearline PV16 ____ 2
- F16-LL ____ 1
- F16-LR ____ 1

1 x 4

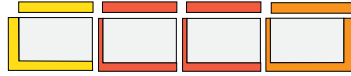

- Clearline PV16 ____ 4
- F16-LL ____ 1
- F16-LC ____ 2
- F16-LR ____ 1

2 x 2



- Clearline PV16 ____ 4
- F16-LL ____ 1
- F16-LC ____ 0
- F16-LR ____ 1
- F16-LY ____ 1
- F16-LJ ____ 1

2 x 3

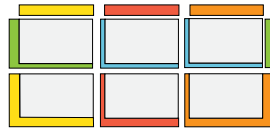

- Clearline PV16 ____ 6
- F16-LL ____ 1
- F16-LC ____ 1
- F16-LR ____ 1
- F16-LY ____ 1
- F16-LJ ____ 2

2 x 4

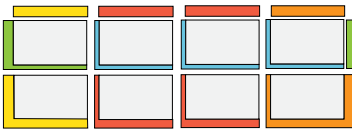

- Clearline PV16 ____ 8
- F16-LL ____ 1
- F16-LC ____ 2
- F16-LR ____ 1
- F16-LY ____ 1
- F16-LJ ____ 3

2 x 1



- Clearline PV16 ____ 2
- VAL16 ____ 1
- F16-LY ____ 1

3 x 3

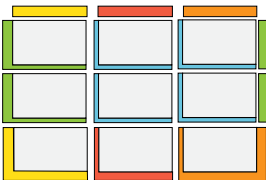

- Clearline PV16 ____ 9
- F16-LL ____ 1
- F16-LC ____ 1
- F16-LR ____ 1
- F16-LY ____ 2
- F16-LJ ____ 4

n x m

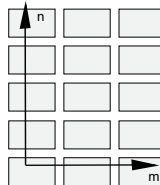

- Clearline PV16 ____ (n x m)
- F16-LL ____ 1
- F16-LC ____ (m-2)
- F16-LR ____ 1
- F16-LY ____ (n-1)
- F16-LJ ____ (n-1) x (m-1)

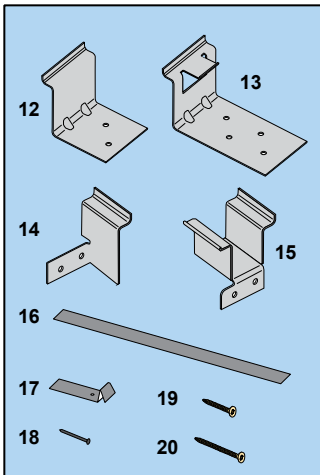
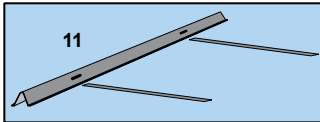
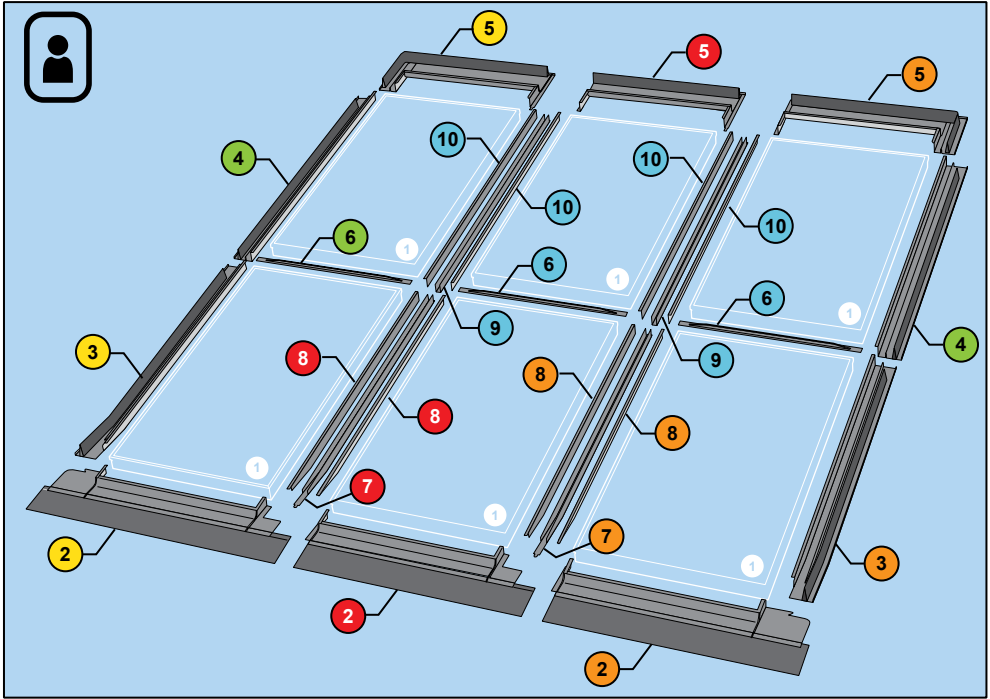

	TL	TC	TR	TY	J
1					
2	1	1	1		
3	1		1		
4				2	
5	1	1	1		
6				1	1
7		1	1		
8		2	2		
9					1
10					2
11	1	1	1		
12	4	4	4		
13				2	2
14	3		3	6	
15		3	3		3
16		1	1		1
17	6		6	12	
18	6	1	7	12	1
19	6	6	12	12	6
20	8	8	8	8	8

EN

Portrait

1 Clearline PV16	11 Tile support
2 Sill flashing	12 Rafter bracket
3 Lower side flashing	13 Combi rafter bracket
4 Upper side flashing	14 Batten bracket
5 Top flashing	15 Combi batten bracket
6 Joining strip	16 Gutter fixing strip
7 Lower gutter	17 Side fixing tab
8 Lower gutter cover	18 Nail
9 Upper gutter	19 4 x 25mm screw
10 Upper gutter cover	20 4 x 50mm screw

DE

Hochformat

1 Clearline PV16	11 Dachziegelhalterung
2 Schwelereindeckrahmen	12 Dachsparrenhalter
3 unterer Seiteneindeckrahmen	13 Kombi-Dachsparrenhalter
4 oberer Seiteneindeckrahmen	14 Dachlattenhalter
5 Eindeckrahmen-Oberteil	15 Kombi-Dachlattenhalter
6 Verbindungsleiste	16 Ablaufrinnenbefestigungsleiste
7 untere Ablaufrinne	17 Seitenrahmenbefestigungslasche
8 untere Ablaufrinnenabdeckung	18 Nagel
9 obere Ablaufrinne	19 4 x 25mm Schraube
10 obere Ablaufrinnenabdeckung	20 4 x 50mm Schraube

NL

Portretgericht

1 Clearline PV16	11 Ondersteuning dakpan
2 Dorselgootstuk	12 Dakspantbeugel
3 Zijgootstuk onder	13 Gecombineerde dakspantbeugel
4 Zijgootstuk boven	14 Panlatbeugel
5 Bovengootstuk	15 Gecombineerde panlatbeugel
6 Verbindingsstrook	16 Bevestigingsstrip goot
7 Onderste goot	17 Zijtabbevestiging
8 Onderste gootdeksel	18 Spijker
9 Bovenste goot	19 4 x 25mm schroef
10 Bovenste gootdeksel	20 4 x 50mm schroef

NO

Portrett

1 Clearline PV16	11 Støttebrakett for takstein
2 Nedre brakett	12 Sperrebrakett
3 Nedre sidebrakett	13 Kombinert sperrebrakett
4 Øvre sidebrakett	14 Lektebrakett
5 Øvre brakett	15 Kombinert lektebrakett
6 Skjøtelist	16 Festebånd for renne
7 Nedre renne	17 Festebånd side
8 Nedre rennedeksel	18 Spiker
9 Øvre renne	19 4 x 25mm skruer
10 Øvre rennedeksel	20 4 x 50mm skruer

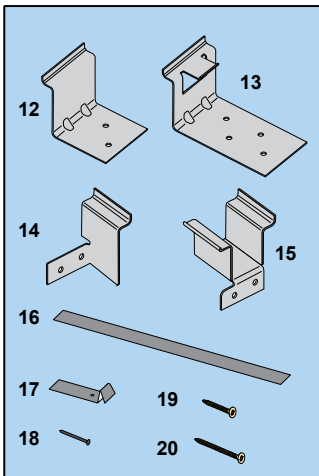
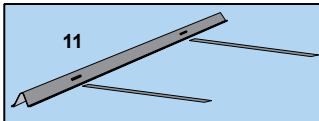
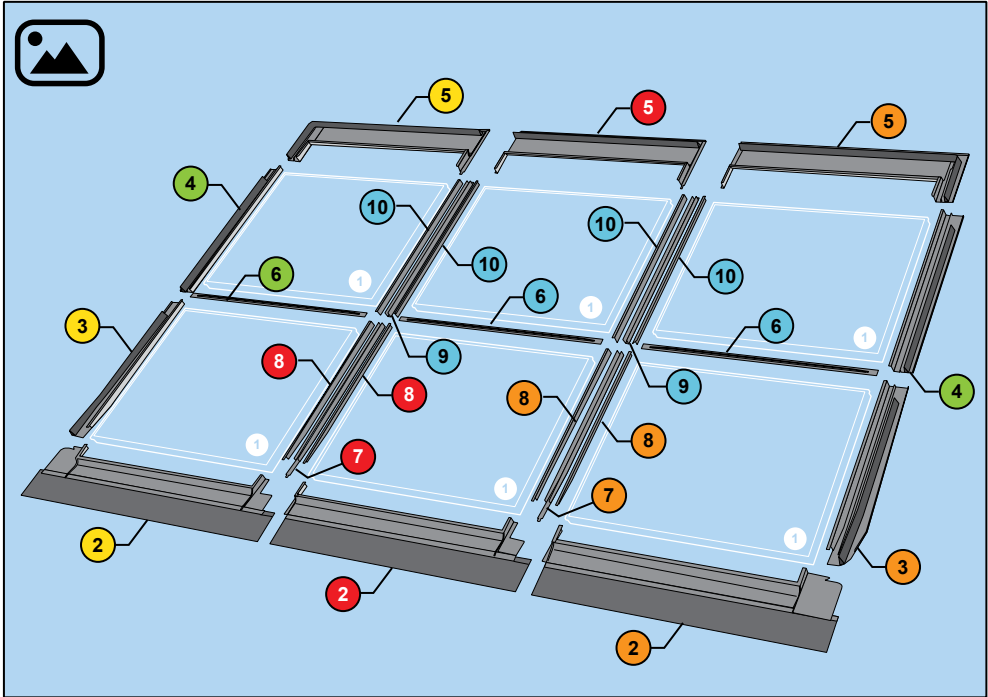

	LL	LC	LR	LY	LJ
1					
2	1	1	1		
3	1		1		
4				2	
5	1	1	1		
6				1	1
7		1	1		
8		2	2		
9					1
10					2
11	1	1	1		
12	6	6	6		
13				3	3
14	2		2	4	
15		2	2		2
16		1	1		1
17	4		4	8	
18	4	1	5	8	1
19	4	4	8	8	4
20	12	12	12	12	12

EN

Landscape

1 Clearline PV16	11 Tile support
2 Sill flashing	12 Rafter bracket
3 Lower side flashing	13 Combi rafter bracket
4 Upper side flashing	14 Batten bracket
5 Top flashing	15 Combi batten bracket
6 Joining strip	16 Gutter fixing strip
7 Lower gutter	17 Side fixing tab
8 Lower gutter cover	18 Nail
9 Upper gutter	19 4 x 25mm screw
10 Upper gutter cover	20 4 x 50mm screw

DE

Querformat

1 Clearline PV16	11 Dachziegelhalterung
2 Schwellereindeckrahmen	12 Dachsparrenhalter
3 unterer Seiteneindeckrahmen	13 Kombi-Dachsparrenhalter
4 oberer Seiteneindeckrahmen	14 Dachlattenhalter
5 Eindeckrahmen-Oberteil	15 Kombi-Dachlattenhalter
6 Verbindungsleiste	16 Ablaufinnenbefestigungsleiste
7 untere Ablaufrinne	17 Seitenrahmenbefestigungslasche
8 untere Ablaufinnenabdeckung	18 Nagel
9 obere Ablaufrinne	19 4 x 25mm Schraube
10 obere Ablaufinnenabdeckung	20 4 x 50mm Schraube

NL

Landschap

1 Clearline PV16	11 Ondersteuning dakpan
2 Dorpelgootstuk	12 Dakspantbeugel
3 Zijgootstuk onder	13 Gecombineerde dakspantbeugel
4 Zijgootstuk boven	14 Panlatbeugel
5 Bovengootstuk	15 Gecombineerde panlatbeugel
6 Verbindingsstrook	16 Bevestigingsstrip goot
7 Onderste goot	17 Zijtabbevestiging
8 Onderste gootdeksel	18 Spijker
9 Bovenste goot	19 4 x 25mm schroef
10 Bovenste gootdeksel	20 4 x 50mm schroef

NO

Landskap

1 Clearline PV16	11 Støttebrakett for takstein
2 Nedre brakett	12 Sperrebrakett
3 Nedre sidebrakett	13 Kombinert sperrebrakett
4 Øvre sidebrakett	14 Lektebrakett
5 Øvre brakett	15 Kombinert lektebrakett
6 Skjøtelist	16 Festebånd for renne
7 Nedre renne	17 Festebånd side
8 Nedre rennedeksel	18 Spiker
9 Øvre renne	19 4 x 25mm skruer
10 Øvre rennedeksel	20 4 x 50mm skruer

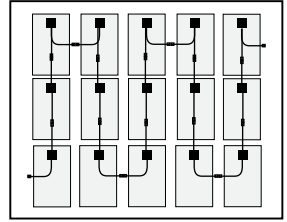
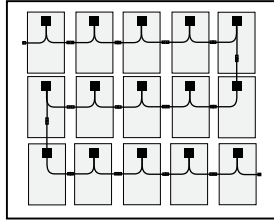
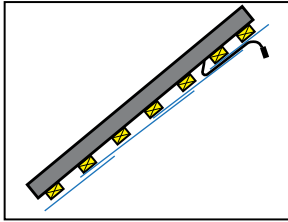

EN

Electrical

Electrically test each solar panel as it is installed.

Cables can be passed through roofing membrane laps for connection inside the building (recommended) or connected to adjacent panels in the batten space.

Choose to connect panels in rows or columns based on consideration of shading and potential difference. Panels can be installed with the junction box at the top or bottom.



Use only genuine Staubli MC4 when connecting to modules

DE

Elektrische Komponenten

Jedes einzelne Solarmodul ist bei der Installation elektrisch zu testen.

Zur Verbindung im Gebäudeinneren können Kabel durch Dichtungsbahnen geführt (empfohlen) oder im Lattenraum mit benachbarten Modulen verbunden werden.

Berücksichtigen Sie bei der Anordnung der Solarmodule in Reihen und Spalten die Verschattung und Potenzialdifferenz. Die Solarmodule können mit der Anschlussdose oben oder unten montiert werden.



Verwenden Sie für den Anschluss der Module ausschließlich originale MC4-Steckverbinder von Stäubli.

NL

Elektrisch

Test elk paneel tijdens de installatie.

Kabels kunnen door doorgangen in het dakbedekkingsmembraan naar binnen worden gebracht voor verdere verbinding binnenin het gebouw (aanbevolen) of de kabels kunnen worden verbonden met aangrenzende panelen binnen de panlatruimte.

Maak een keuze om panelen in rijen (horizontaal) of kolommen (verticaal) te verbinden, gebaseerd op beschaduwing en potentiaalverschil. Panelen kunnen worden geïnstalleerd met de junction box boven- of onderaan.



Gebruik alleen originele Staubli MC4 bij het aansluiten op modules

NO

Elektrisk

Hvert solpanel testes etterhvert som det installeres.

Kabler kan føres gjennom takmembranen for tilkobling inne (anbefalt) eller tilkobles nærliggende paneler i lekteføringen.

Velg om panelene skal tilkobles i rekker eller kolonner basert på skyggeforhold og potensialforskjeller. Panelene kan monteres med koblingsboksen øverst eller nederst.



Bruk utelukkende Staubli MC4 når du kobler sammen modulene

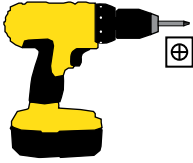

- EN**
-  Flashings may have sharp edges, wear gloves.
 - The installation must comply with local regulations on lightning protection.
 - Viridian Solar recommends that the panel installation is carried out by an installer with roofing competence.

For best results

- Don't rush it.
- Ensure the flashing edges are straight.
- It may be helpful to lubricate gaskets before pushing in the flashing - use glass cleaner for this.

- DE**
-  Die Eindeckrahmenteile können scharfkantig sein. Tragen Sie daher Arbeitshandschuhe.
 - Die Installation muss den örtlichen Vorschriften zum Blitzschutz entsprechen.
 - Viridian Solar empfiehlt Ihnen, die Installation der Module von einem dacherefahrenen Solarinstallateur durchführen zu lassen.

Nützliche Hinweise

- Überstürzen Sie nichts.
- Vergewissern Sie sich, dass die Kanten der Eindeckrahmen gerade sind.
- Schmier Sie gegebenenfalls vor dem Eindrücken der Eindeckrahmen die Dichtungen mit einem Fensterreinigungsmittel.

- NL**
-  De gootstukken hebben vaak scherpe randen en daarom handschoenen dragen.
 - De installatie dient te voldoen aan de gestelde (lokale) eisen inzake bliksembeveiliging.
 - Viridian Solar raadt aan dat de installatie door een installateur met ervaring in dakbedekking gebeurt.

Voor de beste resultaten

- Niet gehaast te werk gaan.
- Wees er zeker van dat de randen van het gootstuk recht zijn.
- Het kan helpen om de pakkingen te smeren voordat het gootstuk wordt aangebracht - gebruik hiervoor alleen glasreinigingsvloeistof.

- NO**
-  Brakettene kan ha skarpe kanter, bruk hansker.
 - Installasjonene må samsvare med gjeldende forskrifter for beskyttelse mot lynnedslag.
 - Viridian Solar anbefaler at solcelle installasjonene utføres av en kvalifisert installatør.

For best resultat

- Unngå hastverk.
- Kontroller at kantene til brakettene er rette.
- Det kan være nyttig å smøre pakningene før du skyver inn blekket i rammen - bruk bare glass rengjørings middel for dette.

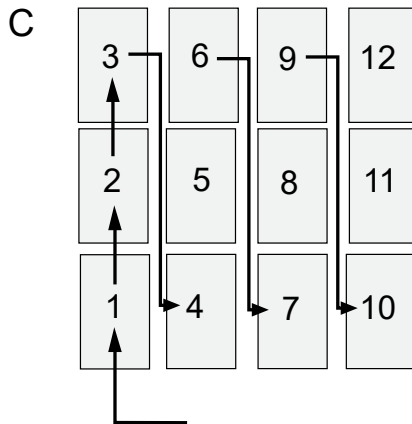
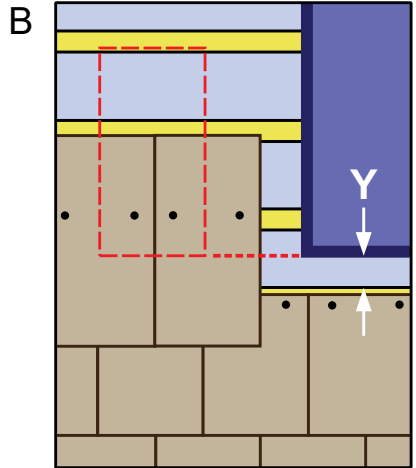
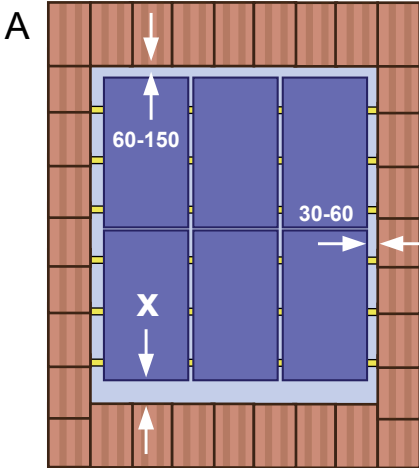

EN



Clearline fusion is intended for installation above a continuous, functional underfelt that terminates in a gutter.

- (A) Interlocking tiles set lower gap 'X' 130-150mm. Reduce for thinner tiles, if unsure - contact us
- (B) Slate. For best results align the bottom edge of panel with the slate line. This may require that slates below the panels are nailed in advance. If installing before slating, set 'Y' to 130mm.
- (C) Start at the bottom left of the array. Move to the right as each column is finished.

DE



Solarmodule der Reihe Clearline Fusion sind für eine Installation auf einem durchgehenden, funktionellen Unterfilz, der in eine Ablaufrinne mündet, gedacht.

- (A) Bei ineinandergreifenden Ziegeln entsteht in der Regel ein unterer Spalt 'X' von 130 – 150 mm. Bei dünneren Ziegeln reduzieren Sie die Spaltbreite. Im Zweifelsfall setzen Sie sich bitte mit uns in Verbindung.
- (B) Schieferplatten. Für das bestmögliche Ergebnis richten Sie die untere Kante der Solarmodule an den Schieferplattenrändern aus. Unter den Solarmodulen liegende Schieferplatten sind gegebenenfalls vorher mit Nägeln zu befestigen. Erfolgt die Installation der Module vor der Schieferdeckung, halten Sie eine untere Spaltbreite 'Y' von 130 mm ein.
- (C) Beginnen Sie eine Reiheninstallation stets unten links. Nach Fertigstellung einer jeden Spalte machen Sie in der nächsten Spalte rechts davon weiter.

NL



ClearlineFusion is bedoeld voor installatie bovenop een aaneengesloten en functionele dakfolie dat eindigt in een goot.

- (A) Bij in elkaar grijpende dakpannen de afstand vaststellen 'X' op 130-150 mm (typisch). Deze afstand verminderen bij dunnere dakpannen. Neem bij twijfel contact met ons op.
- (B) Leien. Voor de beste resultaten de onderzijde van het paneel uitlijnen met de lijn van de onderzijde van de leien. Dit kan betekenen dat de leien onder de panelen op voorhand vastgenageld dienen te worden. Als de installatie voorafgaande aan het leidekken plaatsvindt: 'Y' op 130 mm uitmeten.
- (C) Begin links onderaan de configuratie. Ga naar rechts als elke kolom is voltooid.

NO



Clearline Fusion er beregnet for installering over et funksjonelt undertak.

- (A) Ved selvlåsende takstein, sett spalten 'X' til 130-150mm. Reduser dersom det er tynnere takstein. Kontakt oss ved spørsmål
- (B) Skifer. Juster nedre kant av panelet med skiferkantene for å oppnå best resultat. Det kan hende at skiferen som er montert under panelene må festes først. Hvis panelene installeres før takteking, settes 'Y' = 130mm
- (C) Start i nedre venstre hjørne. Forflytt mot høyre ettersom kolonnene fullføres.

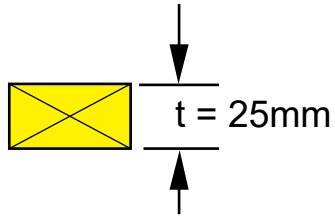
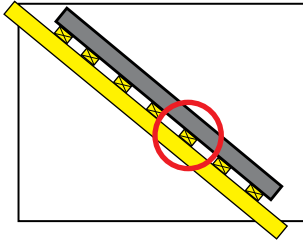

A $t = 22\text{mm}$

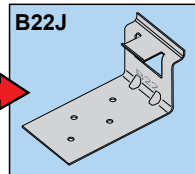
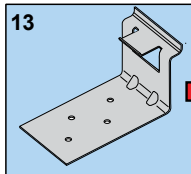
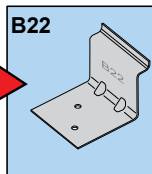
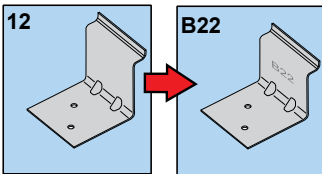

B $t > 25\text{mm}$

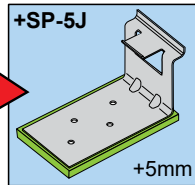
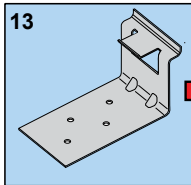
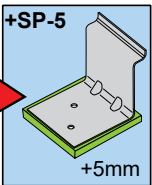
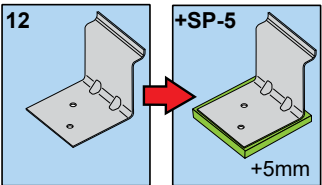

C $t = 0\text{mm}$

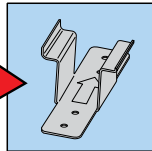
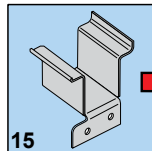
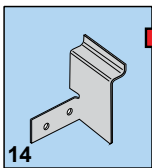
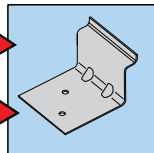
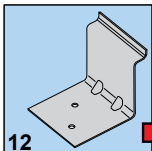

SB16-J
SB16-Y

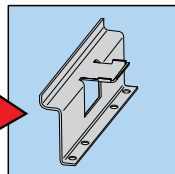
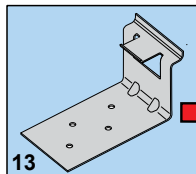

SB16-J

EN TILE BATTENS

Roofing kits are provided with brackets suitable for tile battens of 25mm thickness.

- (A) For 22mm tile battens replace Rafter Brackets (12) with brackets from B22 kit. Replace Combi Rafter Brackets (13) with brackets from B22J kit.
- (B) For tile battens of greater than 25mm thickness, use the required number of 5mm bracket spacers. Use SP-5 for Rafter Bracket (12) and SP-5J for Combi Rafter Bracket (13).
- (C) For roofing without tile battens (direct fix to deck) replace standard brackets with brackets from Sarking Bracket kits as shown, aligning brackets to screw through into rafters below where they cross panels.

DE ZIEGELLATTEN

Die Eindeckrahmenbausätze werden mit Halterungen geliefert, die für 25 mm dicke Ziegellatten geeignet sind.

- (A) Bei Ziegellatten mit einer Dicke von 22 mm ersetzen Sie die Dachsparrenhalter (12) durch Halterungen aus dem Bausatz B22. Ersetzen Sie die Kombi-Dachsparrenhalter (13) durch Halterungen aus dem Bausatz B22J.
- (B) Bei Ziegellatten mit einer Dicke von mehr als 25 mm verwenden Sie die erforderliche Anzahl an 5-mm-Abstandhaltern. Verwenden Sie SP-5 für Dachsparrenhalter (12) und SP-5J für Kombi-Dachsparrenhalter (13).
- (C) Bei Dächern ohne Ziegellattung (direkte Befestigung auf der Schalung) ersetzen Sie die Standardhalterungen wie gezeigt durch die Halterungen aus den Dachschalungsbefestigungssätzen. Richten Sie die Halterungen so aus, dass Sie mit den darunterliegenden Sparren, die die Module kreuzen, verschraubt werden können.

NL PANLATTEN

Dakbedekkingsets worden geleverd met beugels die geschikt zijn voor panlatten met een dikte van 25 mm.

- (A) Voor 22 mm panlatten vervang dakspantbeugels (12) door beugels uit de B22-set. Vervang de gecombineerde dakspantbeugels (13) door de steunen uit de B22J-set.
- (B) Gebruik voor panlatten met een dikte van meer dan 25 mm het vereiste aantal opvulplaatjes van 5 mm. Gebruik SP-5 voor dakspantbeugel (12) en SP-5J voor gecombineerde dakspantbeugel (13).
- (C) Voor dakbedekking zonder panlatten (directe bevestiging op dakplaat) vervangt u standaardbeugels met beugels uit Sarking-beugelsets zoals afgebeeld, waarbij u beugels uitlijnt om vervolgens door te schroeven in spanten eronder waar deze de panelen kruisen.

NO LEKTER

Tak settene er ment for braketter passende for 25 mm lektetykkelse.

- (A) For 22mm lekter, bytt lektebrakettene(13) med braketter fra B22J settet
- (B) For lekter større en 25 mm tykkelse, bruk det anbefalte antall med 5mm brakett spacer. Bruk SP-5 for lekte brakett (12) og SP-5J for kombi lekte braketter (13).
- (C) For tak uten lekter (direkte til undertaket) bytt standard brakettene ut med braketter fra SB brakett settet som vist, juster braketter for å skru gjennom og inn i treverket under der hvor panelene krysser.

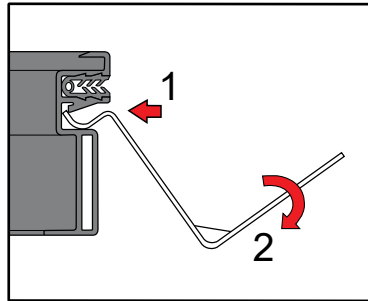
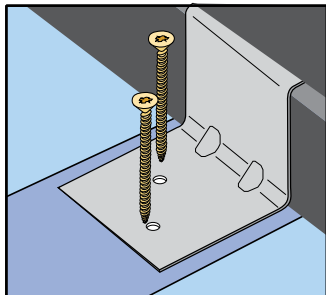
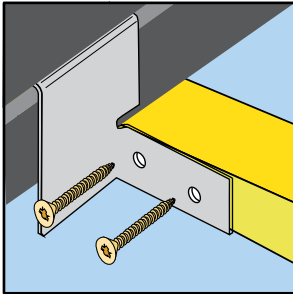
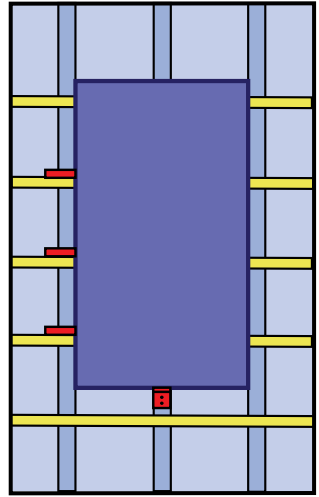
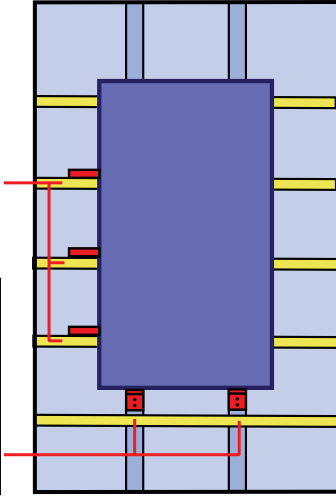
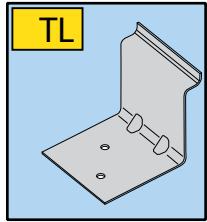
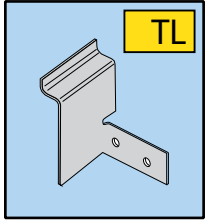
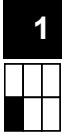

EN

The following portrait 3 above 3 installation illustrates how the system works for any rectangular array. Landscape installation follows the same principles

OPEN THE YELLOW BOX

Start with the bottom left panel. Brackets rotate into the lower slot on the panel frame. Fix the batten brackets (14) to the left side with two 25mm screws (19) each. Fix rafter brackets (12) at the bottom to each rafter the panel crosses with two 50mm screws (20) each.

DE

Die folgende Hochformatinstallation einer 3-über-3-Solarmodulanordnung veranschaulicht die Funktionsweise des Systems für beliebige rechteckige Anordnungen. Installationen im Querformat folgen den gleichen Prinzipien.

ÖFFNEN SIE DIE GELBE BOX

Beginnen Sie mit dem Modul unten links. Die Halterungen drehen sich in die untere Nut des Modulrahmens. Die Dachlattenhalter (14) jeweils mit zwei 25-mm-Schrauben (19) an der linken Seite befestigen. Anschließend befestigen Sie die Dachsparrenhalter (12) unten an jedem Sparren, den das Modul kreuzt, jeweils mit zwei 50-mm-Schrauben (20).

NL

De hierna volgende portretgerichte '3 boven 3'-installatie illustreert hoe het systeem werkt voor elke rechthoekige reeks. Een landschapsgerichte installatie heeft hetzelfde principe.

OPEN DE GELE DOOS

Begin met het linker paneel. Beugels in de onderste sleuf op het paneelframe draaien. Bevestig de panlatbeugels (14) elk met twee 25 mm schroeven aan de linkerkant (19). De dakspantbeugels (12) onderaan elke dakspant vastschroeven, elk met twee 50 mm schroeven (20) waar het paneel de dakspant overlapt.

NO

Følgende portrett illustrerer hvordan systemet fungerer for enhver rektangulær matrise. Landskapsinstallasjonen følger de samme prinsippene

Åpne den gule boksen

Start med panelet nederst til venstre. Brakettene monteres i nedre spor i rammen til panelet. Lektebrakettene monteres (14) til venstre med to 25mm skruer (19) hver. Deretter monteres sperrebrakettene nederst til hver sperre som panelet krysser med to 50mm skruer (20) hver

2

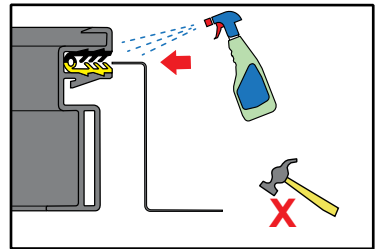
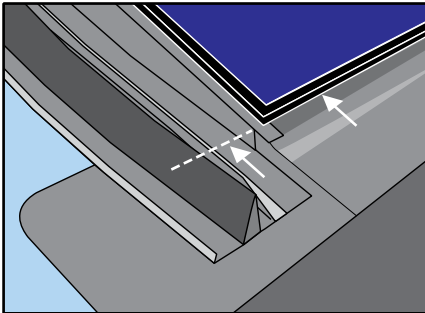
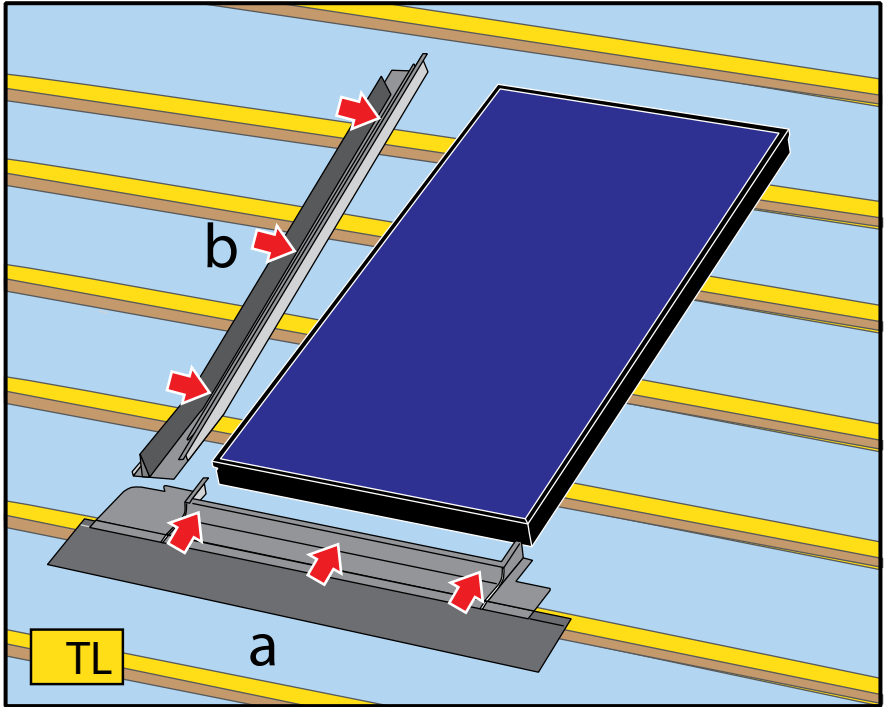

EN Fit the sill flashing (2) then the lower side flashing (3) to the panel. Flashings push into the rubber gasket seal in the upper slot of the panel frame. Take care to align the leading edge just above the yellow line on the gasket. If lubrication is required, use glass cleaning fluid.

DE Den Schwellereindeckrahmen (2) und den unteren Seiteneindeckrahmen (3) an das Modul montieren. Drücken Sie die Eindeckrahmenteile in die Gummidichtung in der oberen Nut des Modulrahmens. Richten Sie die Vorderkante dabei so aus, dass sie knapp über der gelben Linie auf der Dichtung liegt. Schmieren Sie gegebenenfalls die Dichtungen mit Fensterreinigungsmittel.

NL Breng de dorpelgootstuk (2) en vervolgens het zijgootstuk onder (3) aan op het paneel. Gootstukken in de rubberen pakkingafdichting in de bovenste gleuf van het paneelframe duwen. Zorg ervoor dat de voorste rand net boven de gele lijn op de pakking is uitgelijnd. Als smering vereist is, gebruik dan glasreinigingsvloeistof.

NO Monter braketter (2) deretter den nedre braketter (3) til panelets ramme. Skyv inn braketter i gummipakningen i det øvre sporet på panel rammen. Pass på at kanten på braketter plasseres rett over den gule linjen på pakningen. Hvis det er behov for smøring bruk glassrensveske.

3

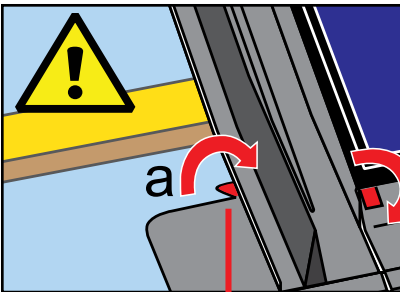
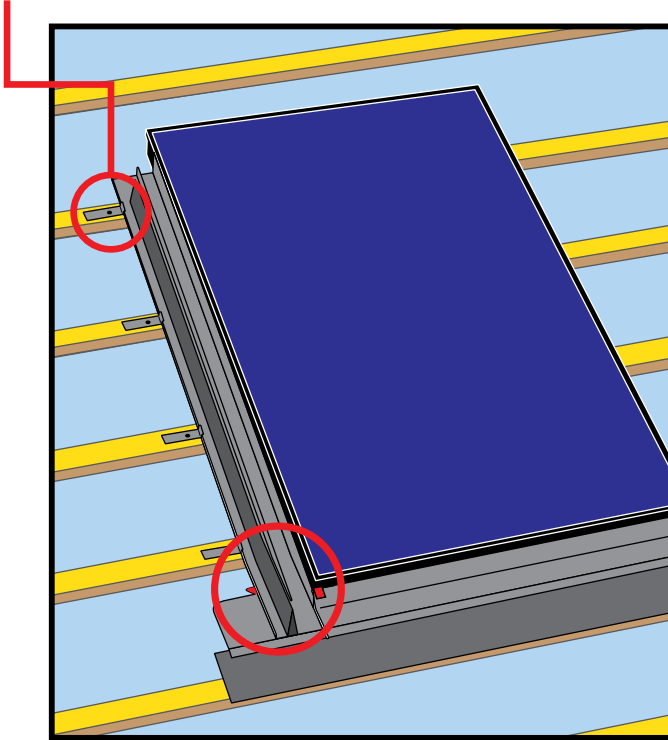
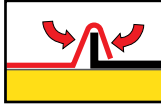
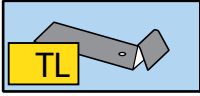

EN Secure the edge of the side flashing using side fixing tabs (17) and nail (18). Fold over the tab on the sill flashing (a) to grip the side flashing. Fold down the tab on the side flashing (b).

DE Sichern Sie die Kante des Seiteneindeckrahmens mit den Seitenrahmenbefestigungslaschen (17) und den Nägeln (18). Verbinden Sie mithilfe der Lasche den Schwellereindeckrahmen (a) mit dem Seiteneindeckrahmen, sodass die Teile ineinandergreifen. Die Lasche auf dem Seiteneindeckrahmen nach unten umbiegen (b).

NL Zet de rand van het zijgootstuk vast met behulp van de tabs (17) en spijker deze vervolgens vast (18). Vouw de tab over het onderste gootstuk (a) om grip op het zijgootstuk te krijgen. De tab op het zijgootstuk naar beneden omvouwen (b).

NO Kanten på sidebraketter festes ved hjelp festebånd (17) og spiker (18). Brett over kanten på den nedre braketter (a) for å få feste til sidebraketter. Brett deretter ned kanten på sidebraketter (b)

4

TY-A

TY-A

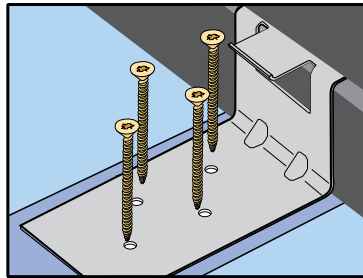
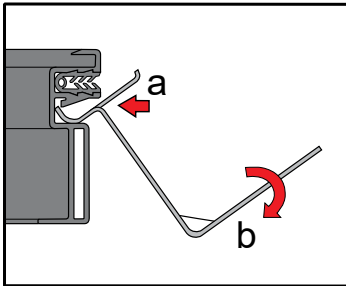
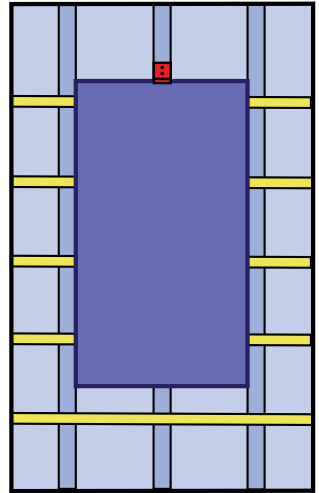
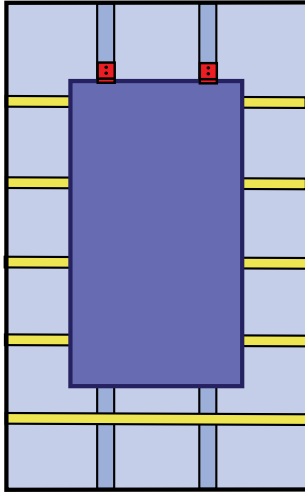
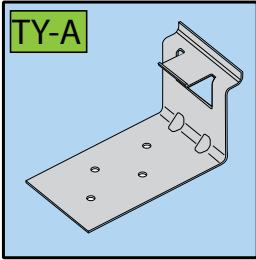

EN OPEN THE GREEN BOX
Fix combi rafter brackets (13) to each rafter the panel crosses with four 50mm screws (20) each.

DE ÖFFNEN SIE DIE GRÜNE BOX
Befestigen Sie die Kombi-Dachsparrenhalter (13) an jedem Sparren, den das Modul kreuzt, mit jeweils vier 50-mm-Schrauben (20).

NL OPEN DE GROENE DOOS
Bevestig de gecombineerde dakspantbeugels (13) aan elke dakspant waar het paneel overlapt d.m.v. vier 50 mm schroeven (20) elk.

NO ÅPNE DEN GRØNNE BOKSEN
Fest kombi-sperrebrakettene (13) til hver sperre som panelet krysser med fire 50mm skruer (20) hver

5

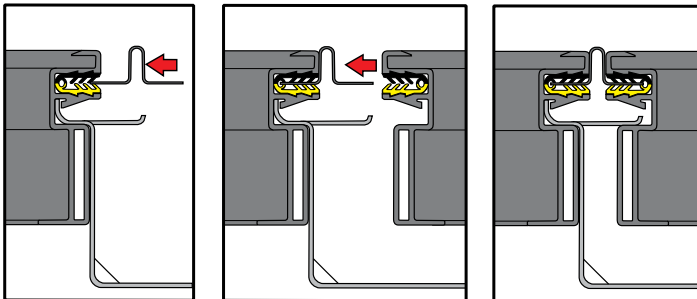
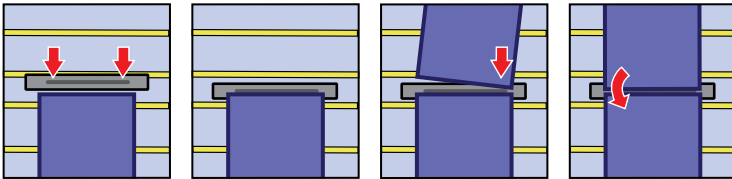
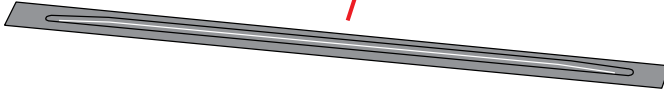
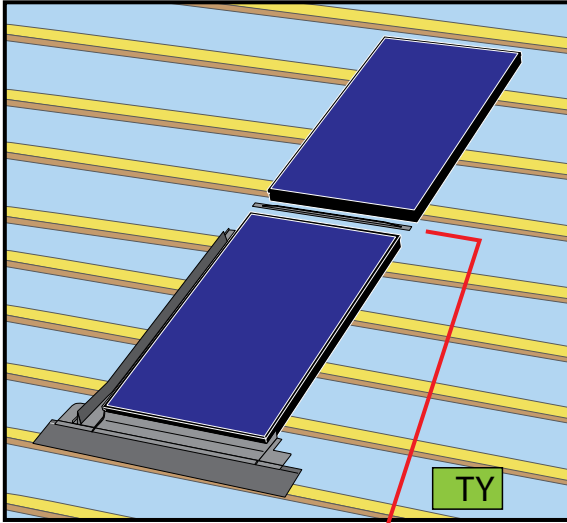

EN Push the joining strip (6) into the gasket on the top face of the lower solar panel. Align to the centre of the panel.

Slide the upper solar panel down the roof to simultaneously engage with the combi-bracket and the joining strip. Aligning the panels on the right corner then rotating the left corner downwards ensures a smooth connection.

DE Drücken Sie die Verbindungsleiste (6) in die Dichtung an der oberen Kante des unteren Solarmoduls. Zur Mitte des Moduls hin ausrichten.

Schieben Sie das obere Solarmodul langsam dachabwärts, um es mit dem Kombi-Dachsparrenhalter und der Verbindungsleiste ineinandergreifen zu lassen. Für eine reibungslose Verbindung setzen Sie an der rechten Modulecke an und lassen das Modul mit einer drehenden Bewegung nach links unten gleiten.

NL Duw de bevestigingsstrook (6) in de pakking op het bovenzvlak van het onderste zonnepaneel. Uittlijnen naar het midden van het paneel.

Schuif het bovenste zonnepaneel over het dak naar beneden om de combibeeugel en de verbindingsstrip te koppelen. Vervolgens uittlijnen van de panelen in de rechterhoek en dan de linkerhoek naar beneden draaien, hetgeen zorgt voor een soepele verbinding.

NO Skjøtelisten (6) skyves inn i pakningen på oversiden av det nederste solpanelet. Juster denne til midten av panelet

Skv det øvre solpanelet nedover taket for samtidig å koble det sammen med kombinasjonsbraketten og skjøtelisten. Ved å justere panelene i høyre hjørne og rotere det venstre hjørnet nedover får man en sikker og jevn tilkobling

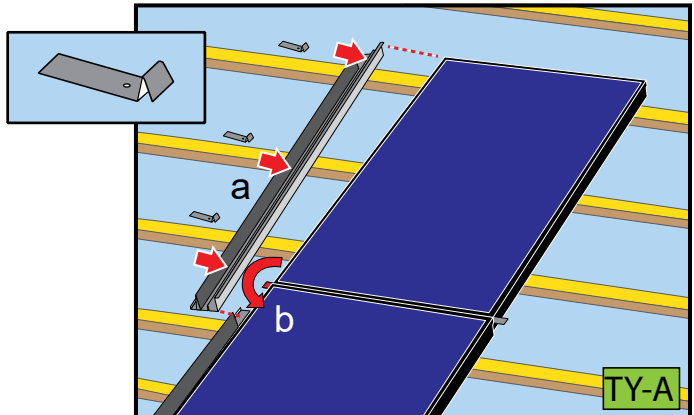
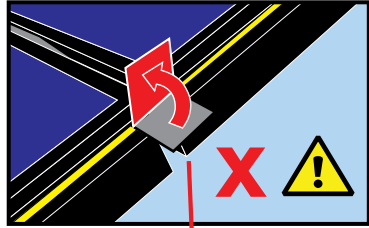
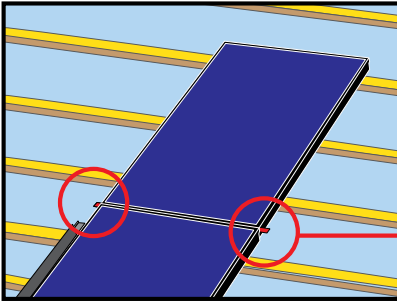
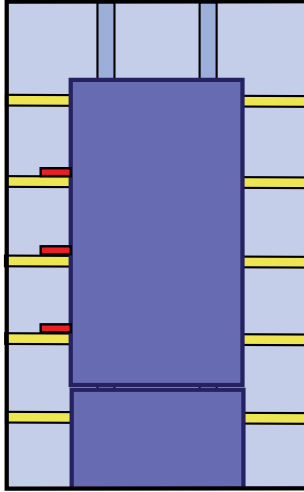
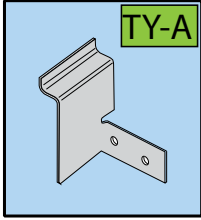
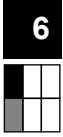

EN Fix the left side of the solar panel with batten brackets (14) and 25mm screws (19). Push in the upper side flashing (4) and fix the outside edge with side fixing tabs (17).

Fold the protruding end of the joining strip (6) down over the side flashing.



Do not fold the protruding end of the joining strip upwards

DE Befestigen Sie die linke Seite des Solarmoduls mit Dachlattenhaltern (14) und 25-mm-Schrauben (19). Den oberen Seiteneindeckrahmen (4) festdrücken und die Außenkante mit Seitenrahmenbefestigungslaschen (17) befestigen.

Das überstehende Ende der Verbindungsleiste (6) über den Seiteneindeckrahmen nach unten umbiegen.



Das überstehende Ende der Verbindungsleiste nicht nach oben umbiegen.

NL Bevestig de linkerkant van het zonnepaneel met panlatbeugels (14) en 25 mm schroeven (19). Duw het bovengootstuk (4) vast en zet de buitenrand vast met de zijtabbevestiging aan de zijkant (17).

Vouw het uitstekende einde van de verbindingsstrip (6) naar beneden over het zijgootstuk.



Vouw het uitstekende uiteinde van de verbindingsstrip niet omhoog

NO Fest venstre side av solpanelet med lektebraketter (14) og 25mm skruer (19) Skyv inn den øvre sidebraketten (4) og fest ytterkantene med festebånd (17).

Brett endene av skjøtelistene (6) over sidebrakettene



I brett den utstående endene av skjøtestripen oppover

7

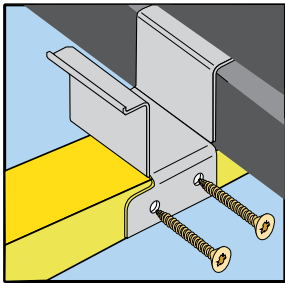
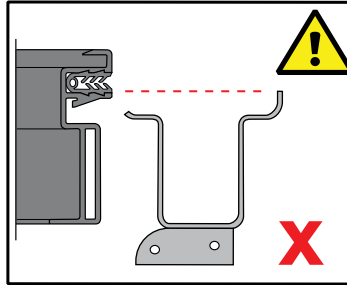
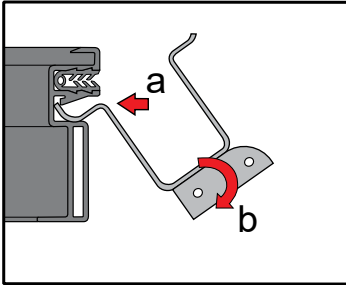
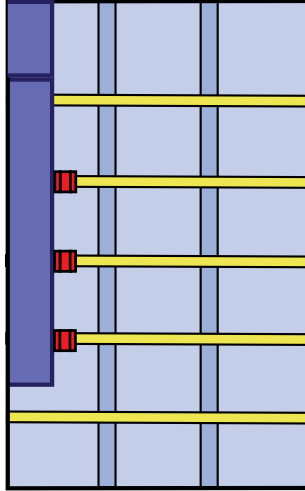
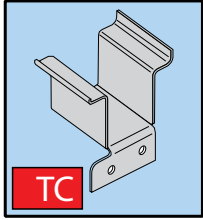

EN

RED BOX

Fix combi-batten brackets (15) to the right hand side of the bottom solar panel. The bracket must be turned so that the side with the taller edge goes into the panel. Fix each brackets with two 25mm screws (19).

DE

ROTE BOX

Befestigen Sie die Kombi-Dachlattenhalter (15) auf der rechten Seite des unteren Solarmoduls. Die Halter so drehen, dass die jeweils höhere Kante in das Modul greift. Danach befestigen Sie jeden Halter mit zwei 25-mm-Schrauben (19).

NL

RODE DOOS

Bevestig gecombineerde panlatbeugels (15) aan de rechterkant van het onderste zonnepaneel. De beugel moet worden gedraaid zodat de zijde met de hogere rand in het paneel gaat. Bevestig elke beugel met twee 25mm schroeven (19).

NO

RØD BOKS

Fest lektebrakettene (15) til høyre på bunnpanelet. Brakettene må vendes slik at siden med den høyeste kanten går inn i panelet.
Fest hver brakett med to 25mm skruer (19).

8

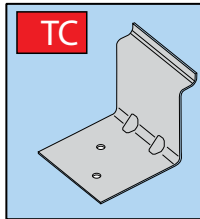
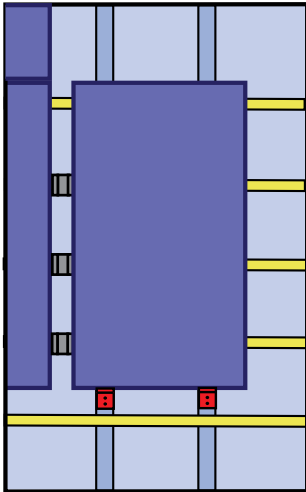
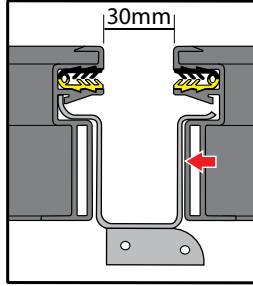
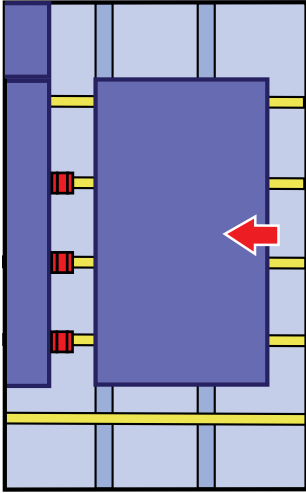

EN

Slide the first panel of the next column sideways to engage with the combi-batten brackets. The bracket sets the gap to 30 mm. Secure the new solar panel to each rafter it crosses with rafter brackets (12) and two 50mm screws (20) each.

DE

Schieben Sie das erste Solarmodul der nächsten Spalte seitwärts, um es mit den Kombi-Dachsparrenhaltern ineinandergreifen zu lassen. Die Halter lassen einen Spalt von 30 mm entstehen. Befestigen Sie das neue Solarmodul an jedem Sparren, den es kreuzt, mit Dachsparrenhaltern (12) und jeweils zwei 50-mm-Schrauben (20).

NL

Schuif het eerste paneel van de volgende kolom zijdelings aan om deze aan te sluiten op de gecombineerde panlatbeugels. Deze beugels bepalen de tussenruimte op 30 mm. Het volgende zonnepaneel op elke dakspant die het overlapt vastzetten met spantbeugels (12) en twee 50 mm schroeven (20) elk.

NO

Skyv det første panelet i den neste kolonnen sidelengs for å hekte det på kombinasjonsbrakettene. Brakettene setter avstanden til 30 mm. Fest det nye solpanelet til hver sperre det krysser med sperrebraketter (12) og to 50mm skruer (20) hver.

9

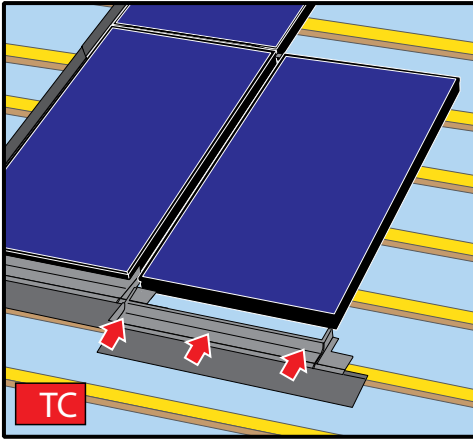

10

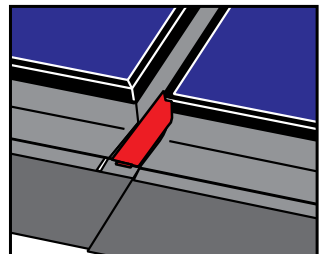
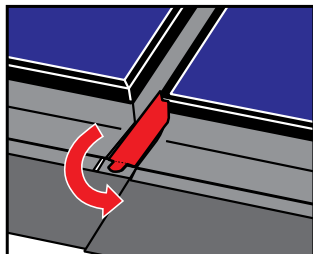
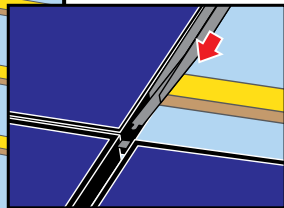
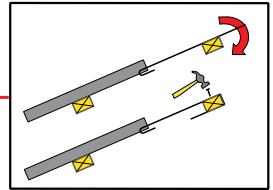
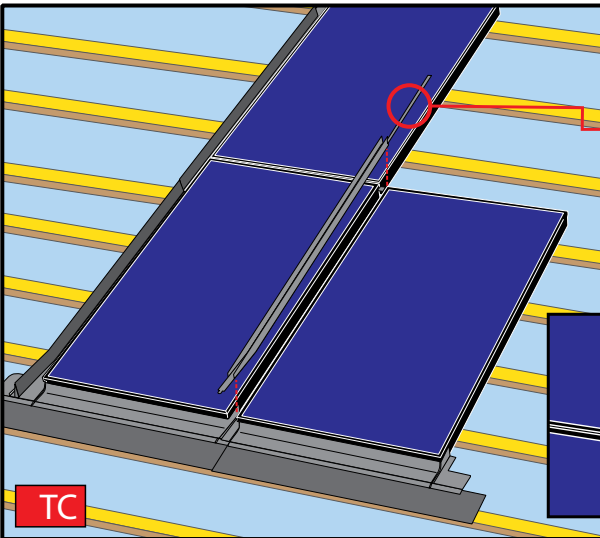

- EN** Push the sill flashing (2) into the gasket on the solar panel.
- Slide the lower gutter (7) between the two solar panels from the top. Fold the tab at the bottom behind the sill flashing. Loop the gutter fixing strip (16) into the slot on top of the gutter. Fix the strip to a batten with a nail.

-
- DE** Drücken Sie den Schwellereindeckrahmen (2) in die Dichtung des Solarmoduls.
- Schieben Sie die untere Ablaufrinne (7) von oben in den Spalt zwischen den beiden Solarmodulen. Biegen Sie die Lasche am unteren Ende um den Schwellereindeckrahmen. Schieben Sie die Ablaufrinnenbefestigungsleiste (16) in die Nut am oberen Ende der Ablaufrinne. Befestigen Sie die Leiste mit einem Nagel an einer Dachlatte.

-
- NL** Duw het dorpelgootstuk (2) in de pakking op het zonnepaneel.
- Schuif de onderste goot (7) tussen de twee zonnepanelen vanaf de bovenzijde. Vouw het tabblad op de bodem achter het dorpelgootstuk. Steek de gootbevestigingsstrip (16) in de gleuf op de bovenkant van de goot. Bevestig de strip op een panlat m.b.v. een spijker.

-
- NO** Skyv den nedre braketten (2) inn i pakningen på solpanelet
- Skyv den nedre rennen (7) mellom de to solpanelene fra toppen. Brett fliken nederst bak den nedre braketten. Festebåndet (16) sløyfes til sporet på toppen av rennen. Fest båndet til en lekte med en spiker

11

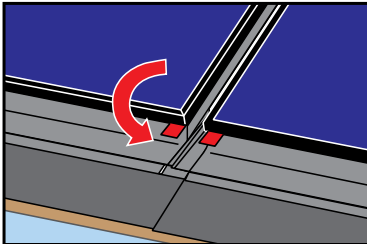
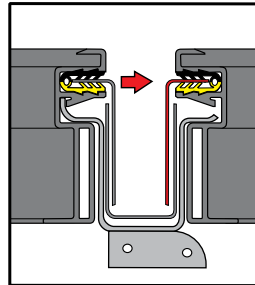
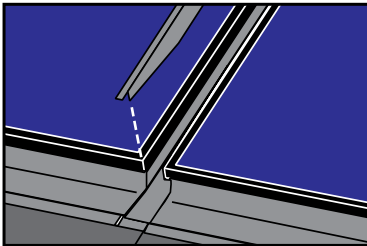
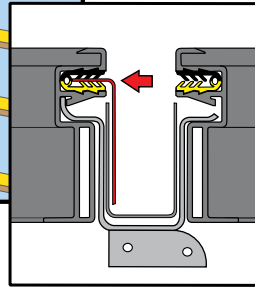
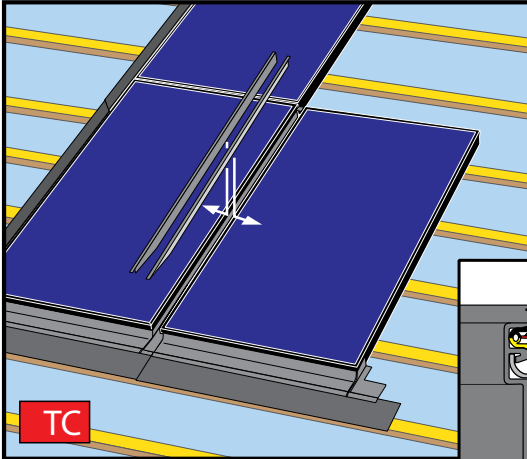

EN Align the bottom corner of the lower gutter covers (8) with the bottom edge of the solar panel and push the gutter covers into the gasket. Fold down the retaining tabs.

DE Richten Sie die unteren Enden der unteren Ablaufrippenabdeckungen (8) am unteren Ende des Solarmoduls aus und drücken Sie die Ablaufrippenabdeckungen in die Dichtung. Biegen Sie anschließend die Haltetaschen nach unten um.

NL Lijn de onderste hoek van de onderste gootdeksel (8) met de onderste rand van het zonnepaneel uit en duw de gootafdekking in de pakking. De tabbevestigingen naar beneden vouwen.

NO Juster det nederste hjørnet av de nedre rennedekslene (8) med den nederste kanten av solpanelet og skyv rennedekslene inn i pakningen. Brett ned festeklaffene

12

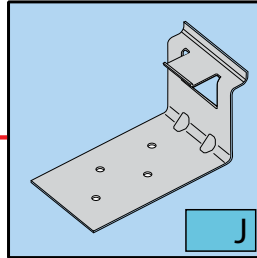
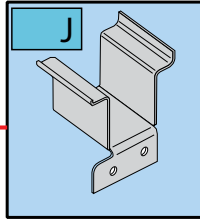
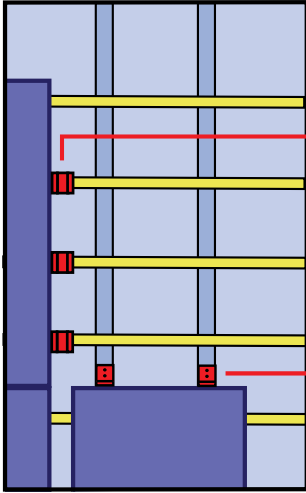

13

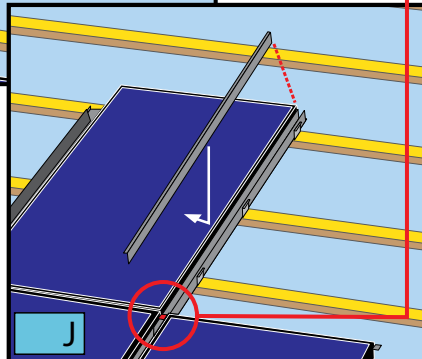
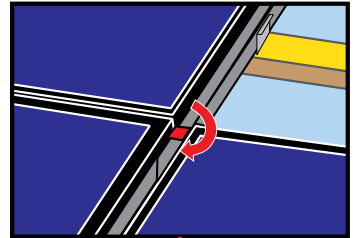
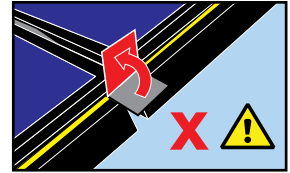
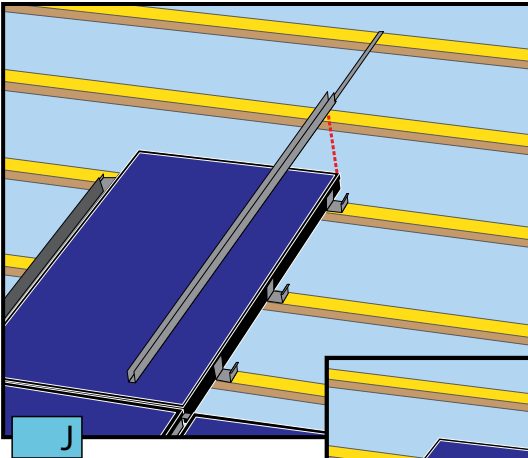

EN

BLUE BOX

Fix combi-rafter brackets (13) to the top of the panel below and combi-batten brackets (15) to the right hand side of the panel to the left.

Fit the upper gutter (9) between the solar panels and nail the gutter fixing strip to a batten. Push the upper gutter cover (10) into the panel gasket. Fold the end of the joining strip down into the gutter.

DE

BLAUE BOX

Befestigen Sie Kombi-Dachsparrenhalter (13) an der Oberseite des unteren Solarmoduls und Kombi-Dachlattenhalter (15) an der rechten Seite des linken Moduls.

Montieren Sie die obere Ablaufrinne (9) zwischen den Solarmodulen und befestigen Sie die Ablaufrinnenbefestigungsleiste mit einem Nagel an einer Dachlatte. Drücken Sie anschließend die obere Ablaufrinnenabdeckung (10) in die Dichtung des Solarmoduls. Biegen Sie danach das Verbindungsleistenende nach unten in die Ablaufrinne um.

NL

BLAUWE DOOS

Bevestig gecombineerde dakspantbeugels (13) aan de bovenkant van het paneel eronder en gecombineerde panlatbeugels (15) aan de rechterkant van het paneel aan de linkerzijde.

Monteer de bovenste goot (9) tussen de zonnepanelen en spijker de gootbevestigingsstrip op een panlat. Duw het bovenste gootdeksel (10) in de paneelpakking. Vouw het einde van de bevestigingsstrook in de goot.

NO

BLÅ BOKS

Fest sperrebrakettene (13) til toppen av panelet nedenfor og lektebrakettene (15) på høyre side av panelet til venstre

Fest den øvre rennen mellom solpanelene og slå fast festebåndet for rennen med spiker til en lekte. Skyv øvre rennedeksel inn i paneelpakningen. Brett enden av skjøllisten ned i rennen.

14

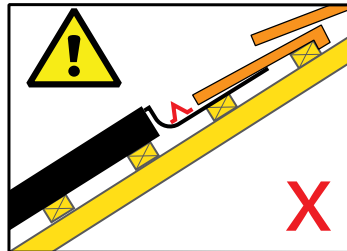
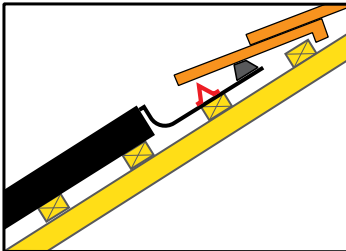
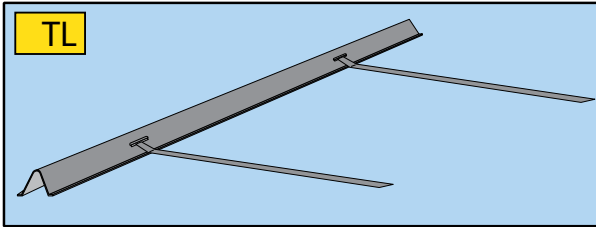
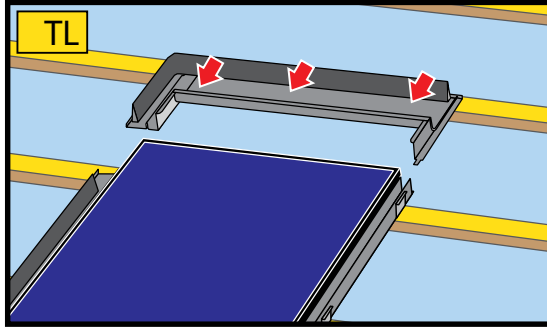
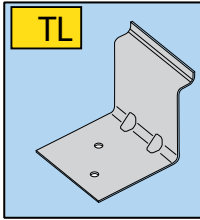

EN For each rafter it crosses, fix a rafter bracket (12) to the top of the top left panel and secure with two 50mm screws (20) each. You may need to add a batten above the panel to support the top flashing. Push the top flashing (5) into the panel gasket. The tile support (11) is needed for some tile types. Feed the two straps under the foam and secure the straps to a batten above.

DE Befestigen Sie an jedem Sparren, den es kreuzt, einen Dachsparrenhalter (12) an der Oberseite des links oben liegenden Moduls und sichern Sie jeden Halter mit jeweils zwei 50-mm-Schrauben (20). Gegebenenfalls ist oberhalb des Moduls eine zusätzliche Dachlatte anzubringen, um das Eindeckrahmen-Oberteil zu stützen. Drücken Sie das Eindeckrahmen-Oberteil (5) in die Dichtung des Solarmoduls. Bestimmte Ziegelarten erfordern eine Dachziegelhalterung (11). Führen Sie die beiden Halteriemen unter den Schaumstoff und befestigen Sie die Riemen an einer darüberliegenden Dachlatte.

NL Voor elk dakspant dat overlapt wordt een dakspantbeugel (12) bevestigen boven het bovenste linker paneel en vastschroeven met twee 50 mm schroeven (20) elk. Het kan nodig zijn om een extra lat toe te voegen boven het paneel om het bovenste gootstuk te ondersteunen. Duw het bovenste gootstuk (5) in de paneelpakking. De dakpanondersteuning (11) is nodig voor sommige soorten dakpannen. Leid de twee bandjes onder het schuim en zet de bandjes op een panlat er boven vast.

NO Monter en sperrebrakett (12) for hver sperre som krysses. Braketten monteres i toppen av panelet mot venstre med to 50mm skruer (20) hver. Det kan hende det må legges til en lekke over panelet for å støtte den øvre braketten. Skyv den øvre braketten (5) inn i paneelpakningen. Støttebraketten for takstein (11) er nødvendig for noen typer takstein. Før stroppene under skumgummien og fest de til en lekke over.

15

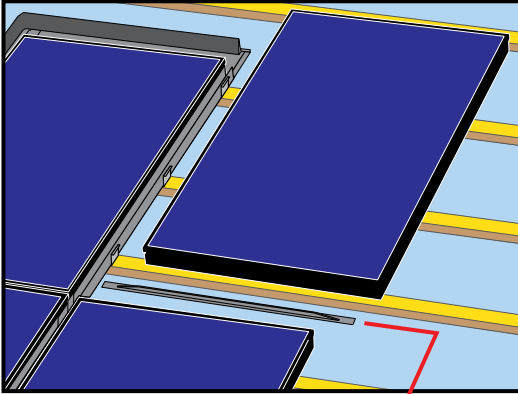

J

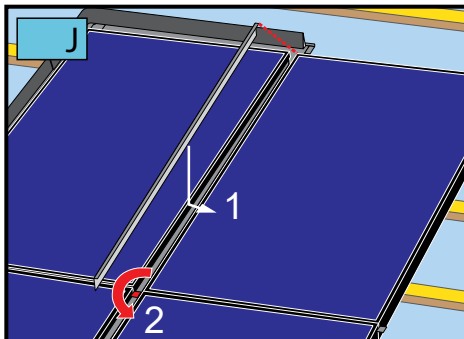
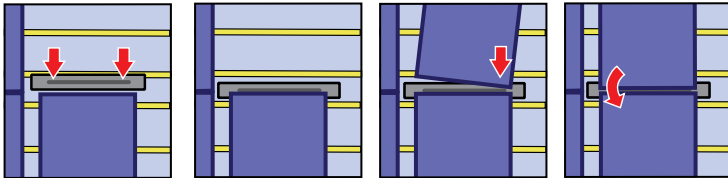
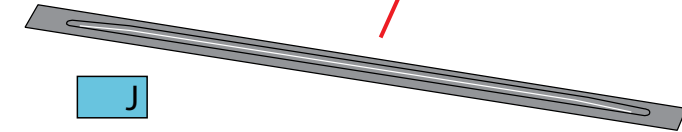

EN

Push the joining strip (6) into the gasket in the top edge of the panel below and slide the solar panel in to engage with the joining strip and combi-brackets on two sides.

Fit gutter cover (10) into the panel gasket. Fold the end of the joining strip down into the gutter.

DE

Drücken Sie die Verbindungsleiste (6) in die Dichtung an der Oberkante des unteren Solarmoduls und schieben Sie das Modul hinein, um es beidseitig mit der Verbindungsleiste und den Kombi-Dachsparrenhaltern ineinandergreifen zu lassen.

Setzen Sie anschließend die Ablaufrinnenabdeckung (10) in die Dichtung des Solarmoduls ein. Biegen Sie nun das Verbindungsleistenende nach unten in die Ablaufrinne um.

NL

Duw de verbindingsstrook (6) in de pakking van de bovenste rand van het paneel eronder en schuif het zonnepaneel aan om te verbinden met deze strook en de gecombineerde panlatbeugels aan beide kanten.

Monteer gootdeksel (10) in de paneel pakking. Vouw het einde van de bevestigingsstrook naar beneden in de goot.

NO

Skyv skjøtelisten (6) inn i pakningen i toppkanten av panelet under og skyv solpanelet inn for å låse det med skjøtelisten og kombibrakettene på sidene.

Monter rennedekselet (10) i panelpakningen. Brett enden av skjøtelisten ned i rennen.

16

TR

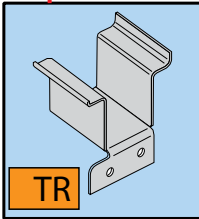
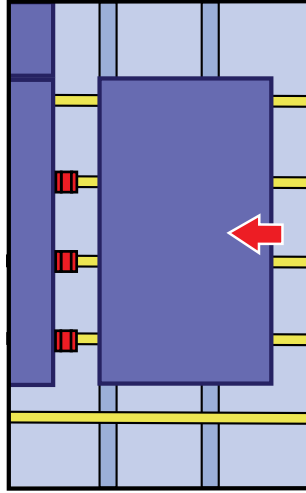
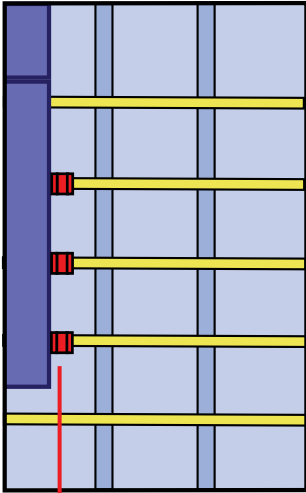

TR

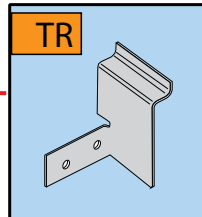
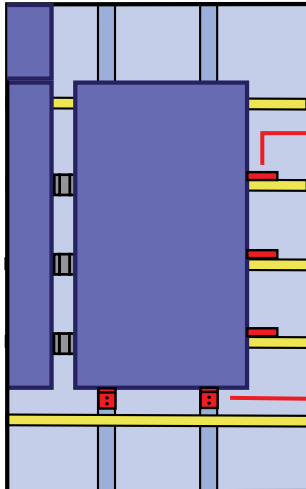

TR

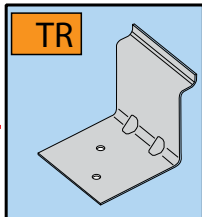

TR

EN

ORANGE BOX

Fix three combi-batten brackets (15) to the right hand side of the panel to the left. Slide the new panel into position. Fix with rafter brackets (12) on the bottom edge and batten brackets (14) to the right hand side.

DE

ORANGE BOX

Befestigen Sie drei Kombi-Dachlattenhalter (15) an der rechten Seite des linken Solarmoduls. Schieben Sie das neue Modul in Position. Mit Dachsparrenhaltern (12) an der Unterkante und mit Dachlattenhaltern (14) an der rechten Seite befestigen.

NL

ORANJE DOOS

Bevestig gecombineerde panlatbeugels (15) aan de rechterzijde van het paneel naar links. Schuif het nieuwe paneel in de juiste positie. Bevestig met spantbeugels (12) aan de onderrand en latbeugels (14) aan de rechterzijde.

NO

ORANSJE BOKS

Monter tre kombi-ektebraketter (15) på høyresiden av panelet til venstre. Skyv det nye panelet på plass. Fest med sperrebraketter (12) i bunnen og ektebraketter (14) på høyre side.

17

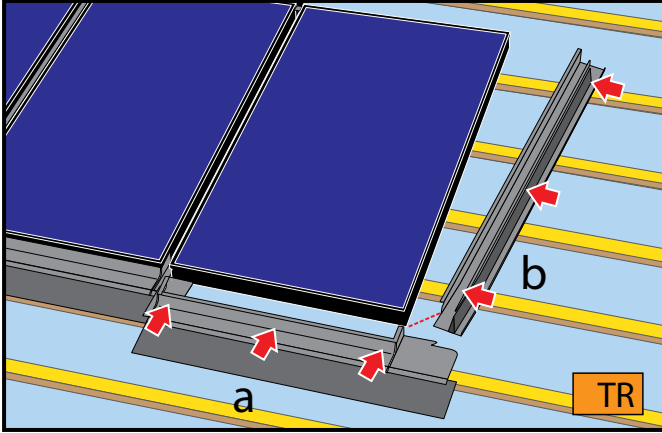

18

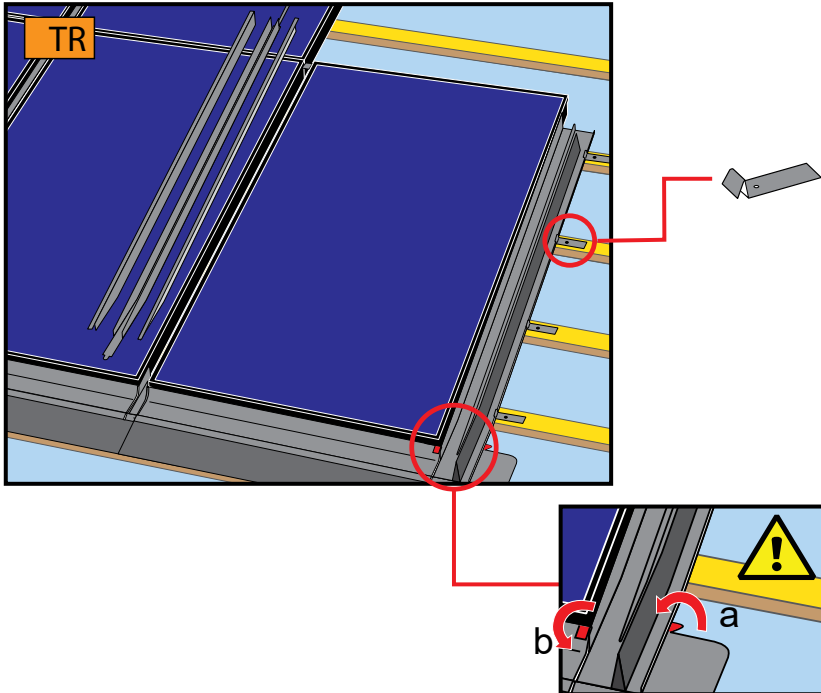

EN

Push the sill flashing (2) into the gasket at the bottom of the solar panel. Push the lower side flashing (3) into the gasket on the right hand side of the panel.

Fit the lower gutter (7), (16) and lower gutter covers (8). See steps 10 and 11.

Fit side fixing tabs (17) and fold over the tab on the sill flashing. See step 3.

DE

Drücken Sie den Schwellereindeckrahmen (2) in die Dichtung am unteren Ende des Solarmoduls und den Seiteneindeckrahmen (3) in die Dichtung an der rechten Seite des Moduls.

Befestigen Sie die untere Ablaufrinne (7), die Ablaufrinnenbefestigungsleiste (16) und die untere Ablaufrinnenabdeckung (8). Siehe dazu die Schritte 10 und 11.

Befestigen Sie die Seitenrahmenbefestigungslaschen (17) und biegen Sie die Lasche auf dem Schwellereindeckrahmen nach unten um. Siehe dazu Schritt 3.

NL

Duw het dorpelgootstuk (2) in de pakking aan de onderkant van het zonnepaneel. Duw het onderste zijgootstuk (3) in de pakking aan de rechterkant van het paneel.

Monteer de onderste goot (7), (16) en de onderste gootafdichtingen (8). Zie stap 10 en 11.

Monteer zijtabbevestiging aan de zijkant (17) en vouw de tab op het dorpelgootstuk. Zie stap 3.

NO

Skyv den nedre braketten (2) inn i pakningen i bunnen av solpanelet. Skyv den nedre sidebraketten (3) inn i pakningen på høyre side av panelet.

Monter den nedre rennen (7), (16) og nedre rennedeksel (8). Se trinn 10 og 11

Monter festebånd for sidene (17) og brett over fliken på den nedre braketten. Se trinn 3

19

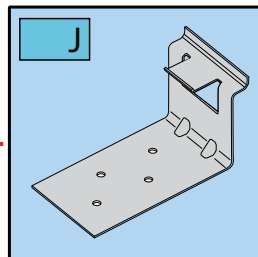
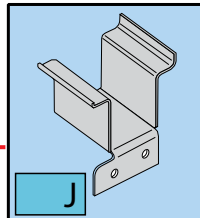
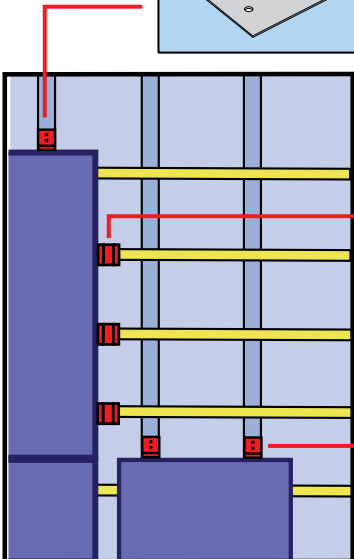
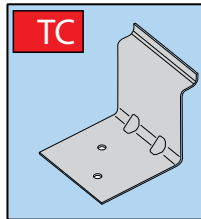
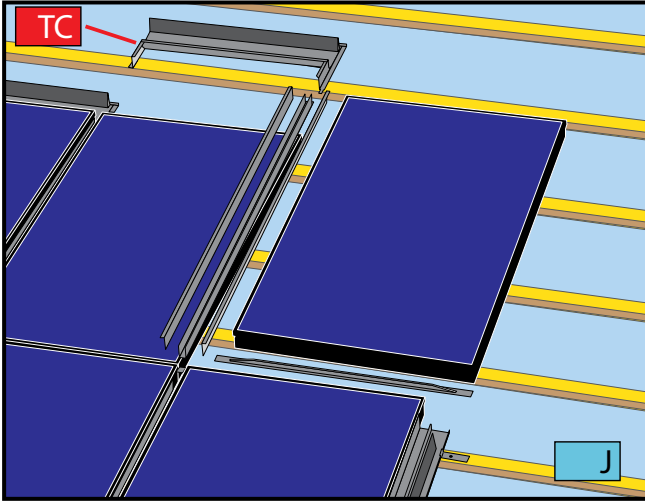

EN

BLUE BOX

Repeat steps 12 to 15 with TC kit and J kit.

DE

BLAUE BOX

Wiederholen Sie die Schritte 12 bis 15 mit den Bausätzen TC und J.

NL

BLAUWE DOOS

Herhaal stap 12 - 15 met het TC-pakket en het J-pakket.

NO

BLA BOKS

Gjenta trinn 12–15 med TC og J.

20

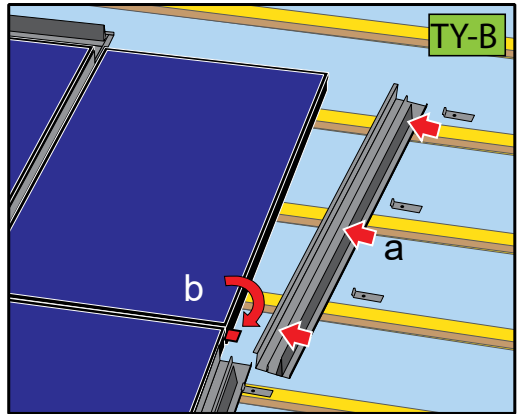
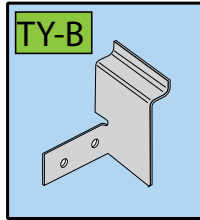
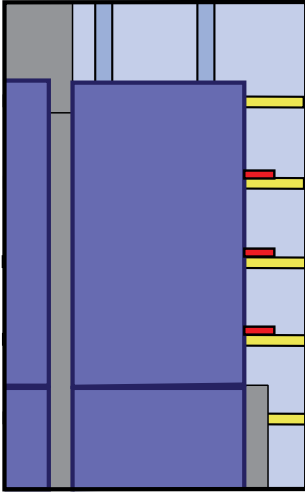

21

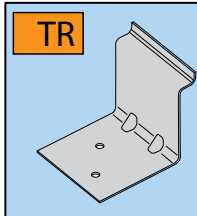
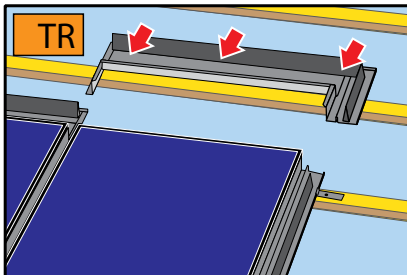

EN

Repeat step 6 to fit batten brackets and upper side flashing

Repeat step 14 with TR kit

DE

Zur Montage der Dachlattenhalter und des oberen Seiteneindeckrahmens wiederholen Sie Schritt 6.

Für den Bausatz TR wiederholen Sie Schritt 14.

NL

Herhaal stap 6 voor montage panlatbeugels en bovenste zijgootstuk.

Herhaal stap 14 met het TR-pakket.

NO

Gjenta trinn 6 for å montere lektebraketter og den øvre sidebraketten.

Gjenta trinn 14 med TR

22

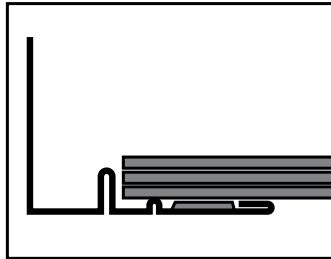
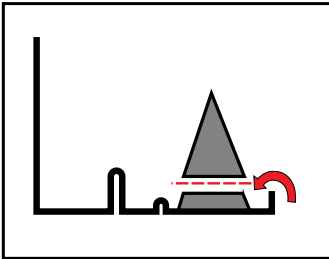
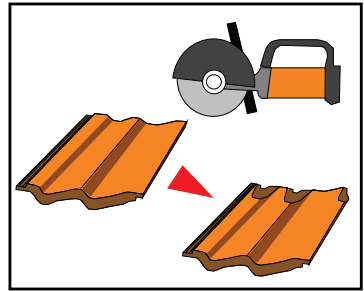
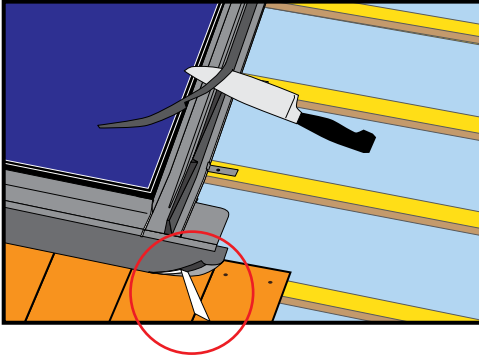

EN

Remove the paper strip on the underside of the sill flashing and dress the lead down onto the tiles. Ensure that the bitumen strip is well-bonded to the tiles. In some circumstances, for example a dusty tile surface, the application of a low modulus external silicone sealant will be required to achieve good adhesion.

For some tile types it may be necessary to chamfer the high points under the sill flashing. Lighter tiles will sit more neatly if the foam surround is trimmed. For slates, trim the foam to within 10mm of its base and flatten over the outside edge of the flashing.

DE

Entfernen Sie den Papierstreifen an der Unterseite des Schwellereindeckrahmens und legen Sie die Bleilappen auf die Dachziegel. Stellen Sie sicher, dass der Bitumenstreifen gut auf den Ziegeln haftet. Unter bestimmten Umständen, beispielsweise bei einer staubigen Ziegeloberfläche, ist das Auftragen eines für die Verwendung im Außenbereich geeigneten niedrigmoduligen Silikondichtmittels erforderlich, um eine gute Haftung zu erzielen.

Bei bestimmten Ziegelarten kann es notwendig sein, etwaige Erhebungen unter dem Schwellereindeckrahmen anzufasen. Leichtere Ziegel liegen ordentlicher, wenn die Schaumstoffeinfassung beschnitten wird. Bei Schieferplatten kürzen Sie den Schaumstoff bis auf 10 mm und streichen ihn über die Außenkante des Eindeckrahmens hin glatt.

NL

Verwijder de papierstrip aan de onderzijde van het dorpelgootstuk en duw de loodslabben op de dakpannen. Zorg ervoor dat de bitumenstrip goed hecht op de dakpannen. In sommige omstandigheden, bijvoorbeeld een stoffig dakpanoppervlak, is het aanbrengen van een externe siliconenkit met lagere elasticiteitsmodulus vereist om een goede hechting te bereiken.

Bij sommige dakpannen kan het nodig zijn de hoge/uitstekende punt(en) onder het dorpelgootstuk af te schuiven. Lichtere dakpannen zullen netter liggen als het aanliggende schuim wordt ingekort. Voor leien, trim het schuim tot 10mm van de basis en strijk het plat over de buitenrand van het gootstuk.

NO

Fjern beskyttelsesfolien under nedre brakett og tilpass blykappa med lim til taksteinen. Forsikre deg om at bitumenstripen er godt festet til underlaget (takstein/fliser). Under enkelte omstendigheter som for eksempel en støvete taksteinoverflate vil det i tillegg være behov for å benytte silicone for å oppnå god vedheft.

For noen typer takstein kan det være nødvendig å trimme av høye kanter for å tilpasse blykappa. Lettere takstein vil sitte bedre hvis skummet rundt trimmes. For skifer, juster skummet innenfor 10mm høyde og press over ytterkanten på braketten.

Viridian Solar
Atlas Building, 68 Stirling Way
Papworth, Cambridge. UK
CB23 3GY
+44 1480 831 501
www.viridiansolar.com

